

Article number: 201242615

Description: E+G
Pin with axial lock GN 124.2-6-15

Measures

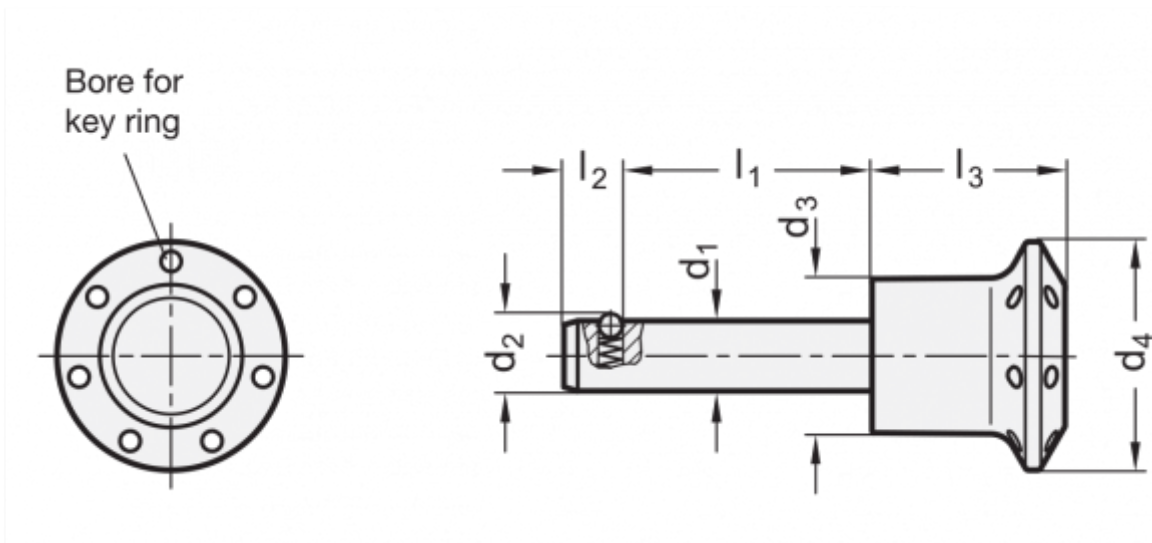

Axial grasping power on pins N = 8	= 8	$l_2 = 5.0$
Bore for pin D12	= 6	$l_3 = 22.5$
d1	= 6	
d2	= 6.5	
d3	= 14.5	
d4	= 25	
Dividing power (double) in kN	= 22	
l1	= 15	